

BeneVision TM80

Telemetry Monitor

Quick Reference Guide

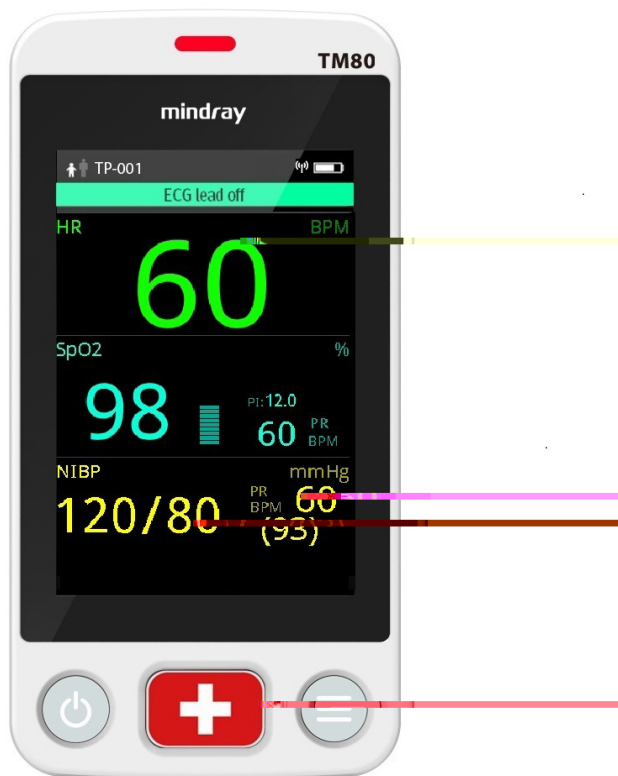

Note: The TM80 Quick Reference Guide is not intended as a replacement to the Operating Instructions. Prior to operating equipment, the user must be familiar with the Operating Instructions Manual contents. This document is a guideline only to be used as an aid to comprehensive Inservice Training.

Table of Contents

TM80 Physical View	1
General Navigation	3
Swipe for More Data	3
View More Data	4
Quick Key/Screen Menu Bar Deployment	5
Patient Setup	6
Admit	6
Discharge	6
Adjust Patient Category	6
Standby	7
Enter Standby	7
Resume Monitoring	8
Printing	8
Nurse Call	8
Activate a Nurse Call	8
Acknowledge the Nurse Call	8
ECG	9
Select ECG Leadwire	9
Lead Placement	10
Enable Pacer	11
Resp	11
Set NCM Alarm Delay	11
SpO₂ (OPTIONAL)	12
Connect the SpO ₂ Module	12
Initiate the SpO ₂ Measurement	13
NIBP (OPTIONAL)	14

Table of Contents (cont'd)

Pair a TM80 with a BP10	14
Pair a TM80 with a New BP10	14
Unpair a TM80 with a BP10 via the TM80	15
Unpair a TM80 with a BP10 via the BP10	15
Technical Alarms	15
Alarm Reset	15
Screen Display	16
Switch Orientation	16
Flip the Landscape Display	16
Adjust Display Order	17
Screen Lock/View Only Mode	17
Enable the Screen Lock	17
Unlock the Screen in Locked Mode	18
Unlock the Screen in View Only Mode	18
Adjust Volumes	18
Parameter Colors	19
Clean/Disinfect the TM80	19
Clean the TM80	19
Disinfect the TM80	23
Clean/Disinfect Reusable Accessories	23
Sterilization	23

TM80 PHYSICAL VIEW

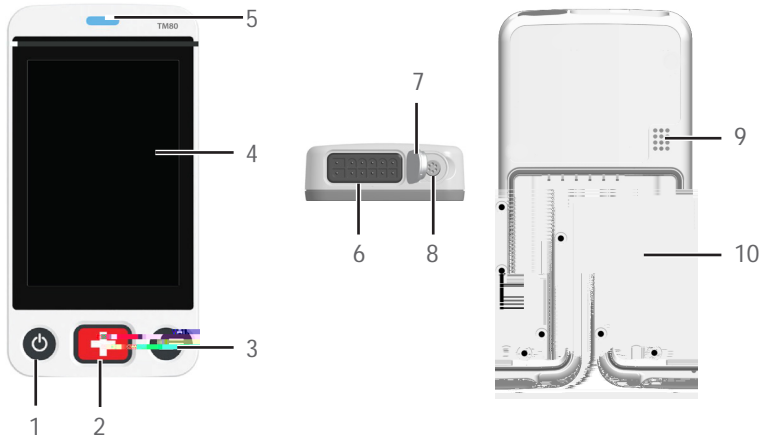

1. Display Activation (Power On/Off) key

When the TM80 is powered off

- Pressing this key will turn the TM80 on.

When the TM80 is powered on

- And the screen display is on, pressing this key will turn the display off.
- And the screen display is off, pressing this key will turn the display on.
- Press and hold this key for two seconds to display the power off confirmation menu.

2. Nurse Call key

Nurse call key activates nurse call message at the Central Monitoring System (CMS).

3. Main Menu key

- Pressing this key when on the main screen will open the main menu.
- Pressing this key when a menu is open will return to the main screen.
- Pressing this key when the display is off will turn the display on.
- Pressing this key when the screen lock mode is configured for View Only will display the **Screen Locked** menu.

4. Display

Touch screen display for viewing patient information and adjusting patient settings.

5. Patient alarm light indicator

6. ECG lead connector

7. SpO₂ cap

Covers SpO₂ connector when SpO₂ is not in use.

8. SpO₂ connector

Connects the SpO₂ module.

9. Speaker

10. Battery compartment

Contains the lithium-ion battery pack or AA battery tray.

GENERAL NAVIGATION

Swipe for More Data

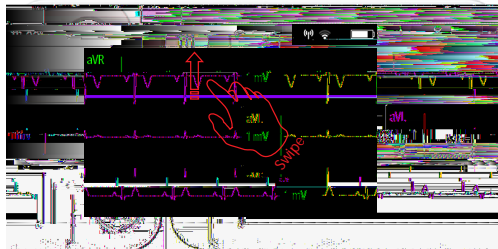
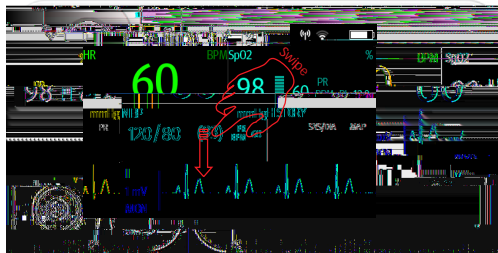
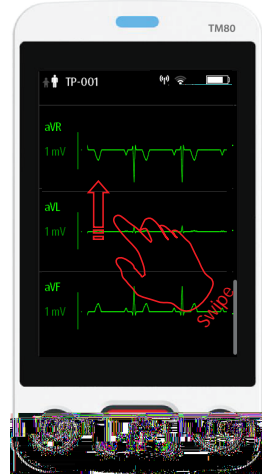
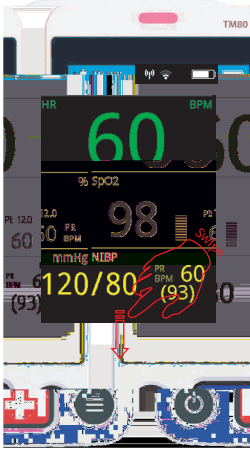

View More Data

The TM80 provides the following shortcuts to access additional information, as shown in the following figures:

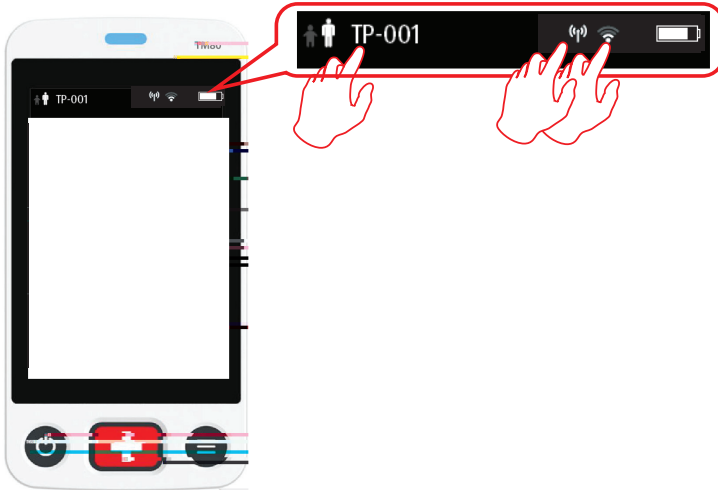

Quick Key Deployment/Screen Menu Bar Deployment



Note: The quick keys are configurable. These images are just representative.

PATIENT SETUP

Admit

After discharging the previous patient, you can admit a new patient by pressing .



Discharge

Discharging the patient will stop monitoring, clear patient information, and restore default (preset) settings on the TM80.

A patient can be discharged by selecting the **Discharge Patient** menu.

Note: Discharging the patient on the TM80 discharges the patient from the CMS.

Select the Discharge Patient menu



1. Press  to enter the main menu.
2. Tap **Discharge Patient**.
3. Select **Yes**.
 - The patient is discharged from both the TM80 and the CMS.
 - The patient's configuration is cleared and the configuration is restored to the saved user configuration or factory default configuration.
 - The patient will be added to the discharged patients list at the CMS.
4. Press  to admit a new patient.

Adjust Patient Category

The Patient Info menu allows the clinician to adjust the patient category.

Note: Ensure the patient category selection is appropriate for the patient before monitoring begins. The supported patient categories are Adult and Pediatric.

To adjust the patient category:

1. Press  to enter the main menu.
2. Tap **Patient Info**.
3. Tap **Patient Category** to select the patient category.
4. Select **Yes** to confirm that the patient category should be changed.
The selected patient category displays to the right of **Patient Category**.
5. Press  to return to the main screen.

Note: The patient category can only be changed on the TM80.

Note: Adjusting patient category restores the TM80 to the default (preset) settings but does not clear patient information or data.

Note: When the device is connected to the CMS, the patient category at the CMS is updated if the patient category is changed on the TM80.

STANDBY

Enter Standby

Placing a device into Standby:

- Suspends patient monitoring.
- Alarms are suspended.
- Displays **Standby** on the screen.
- The screen display automatically turns off after the device enters the Standby mode for 30 seconds.

Note: When connected to the CMS, and a device enters or exits Standby mode, the CMS is also notified to enter or exit Standby mode.

To enter Standby mode:

1. Press  to enter the main menu.
2. Tap **Standby**.
3. Select **Yes** to confirm the device should enter Standby mode.

Resume Monitoring

- Restores patient's settings, resumes alarm notification on the TM80 and the CMS.
- Alarm system is activated.
- The TM80 notifies the CMS of returning to Monitoring mode.

To exit Standby mode:

Press  to exit Standby mode.

PRINTING

The clinician is able to print a strip from the TM80 to the CMS.

To print a strip:

Select **Print** from the quick key area or **Command** section in the main menu.

NURSE CALL

Activate a Nurse Call

Press  to activate a nurse call request to the CMS. The alarm light/indicator will flash cyan, and a "Nurse Call Initiated" message will display in the message area if the display is active.

Acknowledge the Nurse Call

The clinician can acknowledge the nurse call on the TM80.

To acknowledge the nurse call alarm:

1. Press  to enter the main menu.
2. Tap **Attendant Present**.

The "Nurse Call Cancelled" message will display in the message area.



ECG

Select ECG Leadwire

The TM80 allows the clinician to set the ECG Leadwire Type being used. To configure the ECG Leadwire Type:

- On the main screen, tap the HR digital area or ECG waveform area to enter the **ECG** menu.

OR

1. Press  to enter the main menu.
2. Tap **Parameter Setup**.
3. Tap **ECG**.
4. Select **Cable Type**.
5. Select
 - **Auto**: the device automatically sets the leadwire type according to the leads connected.
 - **3 Lead**: to select 3-leadwire set
If the leadwire type is set to 3-lead, the **Smart Lead** option becomes **Monitored Lead**. The clinician can select the preferred lead from the **Monitored Lead**.
 - **5 Lead**: to select 5-leadwire set
All ECG leads display on the main screen.
 - **6 Lead**: to select 6-leadwire set
If the leadwire type is set to 6-lead, both the **Va** and **Vb** are selectable.
6. Press  to return to the main screen.

Lead Placement

The TM80 Lead Placement menu allows the clinician to check the ECG Lead Status and troubleshoot Lead Fault messages. To enter the Lead Placement menu:

- Tap the lead off message on the main screen.

OR

- Press  to enter the main menu, and then tap **Lead Placement**.

The Lead Placement window indicates the lead status.

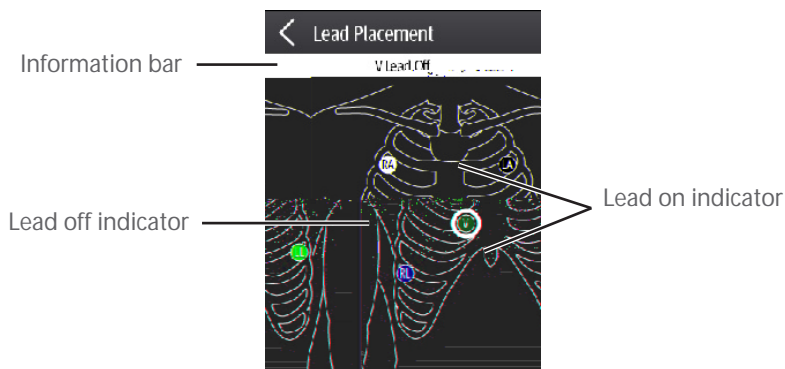

When any of the leads are off, the indications are as follows:

- The lead off message displays on the information bar.
The background color of the information bar corresponds to the alarm level.
- A flashing circle indicates the disconnected lead.
The color of the flashing circle is based on the alarm level.



Enable Pacer

The TM80 allows the clinician to enable pacemaker detection. The  symbol displays in the waveform area on the CMS when the pacemaker detection is enabled.

To enable the pacemaker detection on the TM80:

- On the main screen, select the HR digital area or ECG waveform area to enter the **ECG** menu.

OR

1. Press  to enter the main menu.
2. Tap **Patient Info**.
3. Tap **Paced** to enable Pacer by selecting **Yes**.
4. Press  to return to the main screen.

RESP (OPTIONAL)

Set NCM Alarm Delay

The TM80 allows configuring the desired time for **NCM Alarm Delay**. When the patient has stopped breathing for longer than the set **NCM Alarm Delay** time, the TM80 will trigger the "No Chest Movement" alarm.

To set **NCM Alarm Delay**:

- On the main screen, tap the Resp digital area or Resp waveform area to enter the **Resp** menu.

OR

1. Press  to enter the main menu.
2. Tap **Parameter Setup**.
3. Tap **Resp**.
4. Set **NCM Alarm Delay**.

Note: The "No Chest Movement" alarm is displayed on the Central Monitoring System only.

Note: The Resp functionality for the TM80 telemetry monitor is available at the CMS whose version is 03.00 and above only.

SpO₂ (OPTIONAL)

The TM80 allows continuous pulse oximetry.

Connect the SpO₂ Module

Connect the SpO₂ module to the TM80 as shown in the following figure.

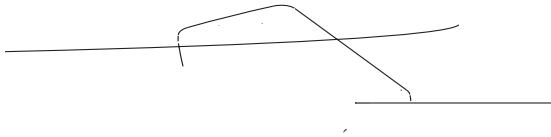

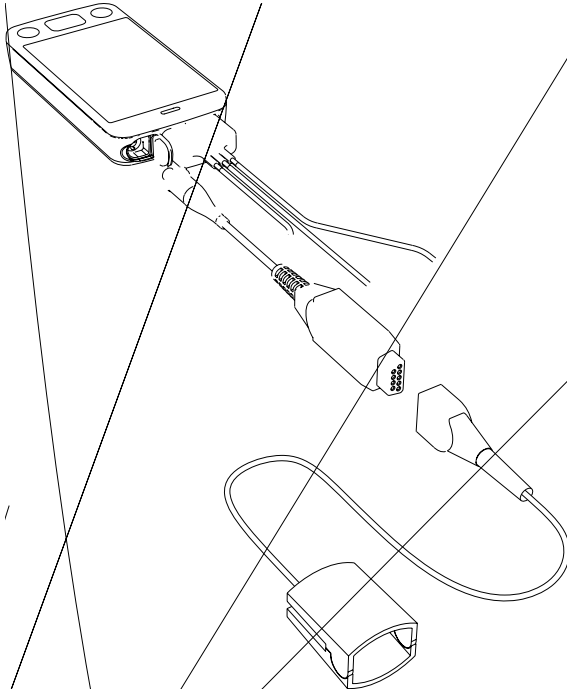

NIBP (OPTIONAL)

The TM80 allows non-invasive blood pressure (NIBP) monitored by a BP10 NIBP module.

Pair a TM80 with a BP10

1. Press the MPAN key on the right panel of the BP10. The "Pairing..." message will display in the message area of the BP10.
2. Press  to enter the main menu.
3. Tap **Wireless Modules**.
4. Tap **MPAN** and then select **Monitor/Sensor**.

The TM80 starts searching the BP10 devices in the vicinity and displays the devices that can be connected under **Devices**. Make sure that the device you wish to connect appears in the list of devices. If not, repeat Steps 1 to 4.

5. In the list of devices, select your desired device and tap **Connect**. Once the device is connected successfully, the status will be changed from **Disconnect** to **Connected**.
6. Tap anywhere in the NIBP digital area on the main screen to access the **NIBP** menu.
7. Tap **Start** to start NIBP measurement. Verify that the NIBP measurement results displayed at the BP10 are consistent with that displayed on the main screen of the TM80 and are the data for the same patient.

Pair a TM80 with a New BP10

1. Unpair the TM80 with the BP10 already connected by following steps in **Unpair a TM80 with a BP10 via the TM80** or **Unpair a TM80 with a BP10 via the BP10**.
2. Pair the TM80 with your desired BP10 by following steps in **Pair a TM80 with a BP10**.

Unpair a TM80 with a BP10 via the TM80

Option 1:

1. Press  to enter the main menu.
2. Tap **Wireles Modules**.
3. Select the device you wish to disconnect from the TM80 from the devices list under **Devices** and tap **Disconnect**.

The connected device is disconnected from the TM80.

Option 2:

1. Press  to enter the main menu.
2. Tap **Wireles Modules**.
3. Tap **MPAN**.
4. Select **Off** or **Sensor**.

Unpair a TM80 with a BP10 via the BP10

1. Press the MPAN key on the BP10.
2. Select **Yes** when the prompt message “**Are you sure you want to close MPAN and unpair BP10?**” appears.

Caution: Before moving a TM80 or BP10 to another area, unpair them first.

Caution: Before admitting a new patient at a BP10, you need to unpair it with a TM80 first.

TECHNICAL ALARMS

Alarm Reset

To silence *an alarm for the duration of the alarm* on the TM80 and the CMS:

1. Press  to enter the main menu.
2. Tap **Alarm Reset** from the **Commands** section.



OR

When **Alarm Reset** is configured as a Quick key, you can

1. Swipe up your finger at the bottom of the main screen to display the quick keys area.
2. Tap the **Alarm Reset** quick key.

After the alarm system is reset, depending upon the system configuration, the alarm system responds as follows:

For the technical alarm:

- The alarm sound will be silenced.
- The alarm light will continue to indicate the alarm.
- A  will appear before the alarm message.
- The  symbol appears on the top of the main screen.

For the technical alarm:

- The alarm sound will be silenced.
- The alarm light will continue to indicate the alarm.
- The alarm will be changed to the prompt message.

For the technical alarm:



- The alarm will be cleared.
- No alarm indications.

SCREEN DISPLAY

Switch Orientation

Adjust Display Order

The TM80 allows the clinician to adjust the parameter order on the main display. To adjust the display order:

1. Press  to enter the main menu.
2. Tap **Display Setup**.
3. To set portrait display orientation, tap **Portrait Order**.
To set landscape display orientation, tap **Landscape Order**.
4. Tap a parameter or waveform
The  parameter icon displays to the right.
5. Drag the selected parameter to the desired position and release.
6. Repeat steps 4 and 5 as needed.
7. Press  to return to the main screen.



SCREEN LOCK/VIEW ONLY MODE

The TM80 provides the ability to lock the touch screen display to restrict user access, options for View Only and Locked are available. View Only allows patient data to be viewed but prevents access to settings without a passcode. Locked requires a passcode for any access to the TM80.



Enable the Screen Lock

After the first time screen lock is enabled, a passcode is required.



To enable the screen lock:

1. Press  to enter the main menu.
2. Tap **Maintenance**.
3. Enter maintenance password.
4. Tap **Accept**.
5. Tap **Screen Lock** to select a screen lock mode: **Locked** or **View Only**.
6. Enter the screen lock passcode.
The selected lock mode is displayed to the right of **Screen Lock**.
7. Press  to return to the main screen.

Unlock the Screen in Locked Mode

1. If the display is off, press  or  to activate the display and access the **Screen Locked** menu.
2. Enter the passcode to unlock the screen.
Once the passcode is entered the screen is temporarily unlocked. If the clinician turns off the TM80 or the display times out, the passcode will need to be re-entered.



Unlock the Screen in View Only Mode

1. If the display is off, press  or  to activate the display.
2. Press  to display the **Screen Locked** menu.
3. Enter the passcode to unlock the screen.
Once the passcode is entered the screen is temporarily unlocked. If the clinician turns off the TM80 or the display times out, the passcode will need to be re-entered.

ADJUST VOLUMES

The clinician is able to adjust alarm volumes, key volumes, and QRS volume on the TM80.



To adjust the volume settings:

1. Press  to enter the main menu.
2. Tap **Audio Volume**.
3. Select the category to adjust and drag the slider to the appropriate volume.
4. Press  to return to the main screen.

PARAMETER COLORS

The TM80 provides the ability to adjust the parameter's numeric and waveform (if applicable) color.

To adjust the parameter's color at the TM80:

1. Press  to enter the main menu.
2. Tap **Parameter Setup**.
3. Tap the parameter.
4. Tap **Color**.
5. Select the color.
6. Press  to return to the main screen.

Note: The parameter color configuration on the TM80 and the CMS are independent.

CLEAN/DISINFECT THE TM80

Clean the TM80

Clean your equipment on a regular basis. Before cleaning, consult your hospital's regulations for cleaning the equipment.

Caution: Never immerse the lithium-ion battery pack, AA battery tray and AA batteries in any fluids.



Before cleaning your TM80, make the following preparation:

- Install the battery pack or battery tray and firmly close to seal the battery compartment.
- Insert the SpO₂ cover in the SpO₂ connector when SpO₂ is not in use.
- Insert the ECG leadwire plug into the ECG connector.

The following table lists approved cleaning and disinfecting agents.

Product Name	Product Type	Ingredients
Sodium hypochlorite bleach*	Liquid	Sodium hypochlorite bleach 10%
Hydrogen peroxide*		Hydrogen peroxide 3%
Isopropanol*		Isopropanol 70%
1-Propanol*		1-Propanol 50%
CIDEX OPA Solution		Ortho-Phthalaldehyde 0.55%
Metrex CaviCide1™		Diisobutylphenoxyethoxyethyl dimethyl benzyl ammonium chloride 0.28%, Isopropanol 17.2%
Virex® II 256		Didecyl dimethyl ammonium chloride 8.704%, n-Alkydimethyl benzyl ammonium chloride 8.190%
Virex®TB		n-Alkyl dimethyl benzyl ammonium chlorides 0.105%, n-Alkyl dimethyl ethylbenzyl ammonium chlorides 0.105%
Rely+On™ Virkon®Powder *(Used as 1% solution)	Powder	Used as 1% solution Biocidal active: Pentapotassium bis (peroxymonosulphate) bis (sulphate)(500g/kg), Contains dipotassium peroxodisulphate.

Product Name	Product Type	Ingredients
PDI Sani-Cloth® Plus Germicidal Disposable Cloth	Wipes	n-Alkyl dimethyl ethylbenzyl ammonium chlorides 0.125%, n-Alky dimethyl benzyl ammonium chlorides 0.125%
PDI Super Sani- Cloth®Germicidal Disposable Wipe*		n-Alkyl dimethyl ethylbenzyl ammonium chlorides 0.25%, n-Alkyl dimethyl benzyl ammonium chlorides 0.25%, Isopropyl Alcohol 55.0%,
VIRAGUARD Hospital Surface Disinfectants		Isopropanol 70%,Other ingredients 30%

Note: For equipment with the symbol , all the listed cleaning and disinfecting agents are available for use. For equipment without the symbol , only the cleaning and disinfecting agents marked with "*" are available for use.

To clean the equipment:

1. Shut down the device.
2. Clean the display screen with wipes or a soft cloth moistened with one of the cleaning agents listed in the table above.
3. Clean the exterior surface of the telemetry monitor main unit and lithium-ion battery pack with wipes or a soft cloth moistened with one of the cleaning agents listed in the table above.
4. Wipe off all the residue with a dry cloth.
5. Dry your equipment in a ventilated, cool place.

Disinfect the TM80

Disinfect your equipment as required in your hospital's servicing schedule using one of the disinfecting agents listed in the table above. Cleaning the equipment before disinfecting is recommended.

CLEAN/DISINFECT REUSABLE ACCESSORIES

To clean and disinfect reusable ECG leadwires and SpO₂ sensors, refer to the instructions for use delivered with the accessory.

STERILIZATION

Sterilization is not recommended for this equipment, related products, accessories or supplies unless otherwise indicated in the instructions for use delivered with the products, accessories or supplies.

Mindray DS USA, Inc.
800 MacArthur Boulevard, Mahwah, New Jersey 07430 USA
Tel: 1.800.288.2121, 1.201.995.8000
www.mindray.com



mindray